

Features

- Compact Metal Case with Excellent Thermal Performance
- Input Over Voltage Protection at 440Vac with 48 Hours
- Full Power at Wide Output Current Range (Constant Power)
- Adjustable Output Current (AOC) with Programmability
- Isolated 0-10V/10V PWM/3-Timer-Modes Dimmable
- Output Lumen Compensation
- Input Surge Protection: DM 4kV, CM 6kV
- All-Around Protection: IOVP, OVP, SCP, OTP
- IP66/IP67
- SELV Output
- 5 Years Warranty



Description

The EAM-240SxxxDB series is a 240W, constant-current, programmable and IP66/IP67 rated LED driver that operates from 90-305Vac input with excellent power factor. It is created for many lighting applications including high bay, high mast and roadway, etc. The high efficiency of these drivers and compact metal case enables them to run cooler, significantly improving reliability and extending product life. To ensure trouble-free operation, protection is provided against input surge, input over voltage, output over voltage, short circuit, and over temperature.

Models

Adjustable Output Current Range(mA)	Full-Power Current Range(mA) ⁽¹⁾	Default Output Current(mA)	Output Voltage Range(Vdc)	Max. Output Power(W)	Typical Efficiency ⁽²⁾	Typical Power Factor		Model Number ⁽³⁾
						120Vac	220Vac	
70-1050	700-1050	700	115-343	240	94.0%	0.99	0.96	EAM-240S105DB
215-3500	2150-3500	2150	35-111	240	93.0%	0.99	0.96	EAM-240S350DB ⁽⁴⁾
420-6700	4200-6700	4900	18-57	240	93.0%	0.99	0.96	EAM-240S670DB ⁽⁴⁾

Notes: (1) Output current range with constant power at 240W

(2) Measured at 100% load and 220Vac input (see below "General Specifications" for details).

(3) Certified input voltage range: 100-240/220-240/240Vac.

(4) SELV output.

I-V Operation Area

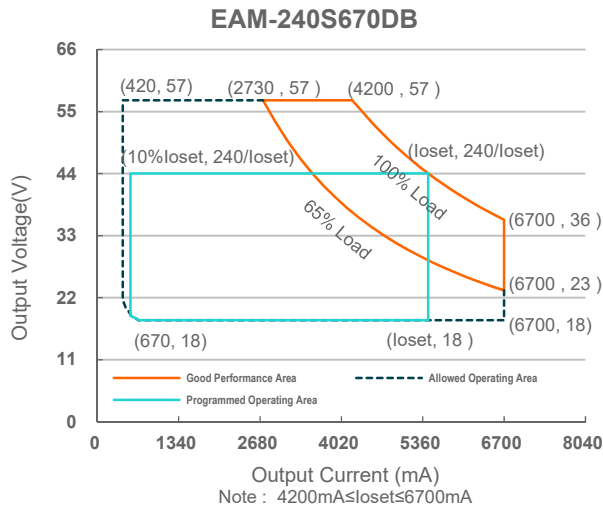
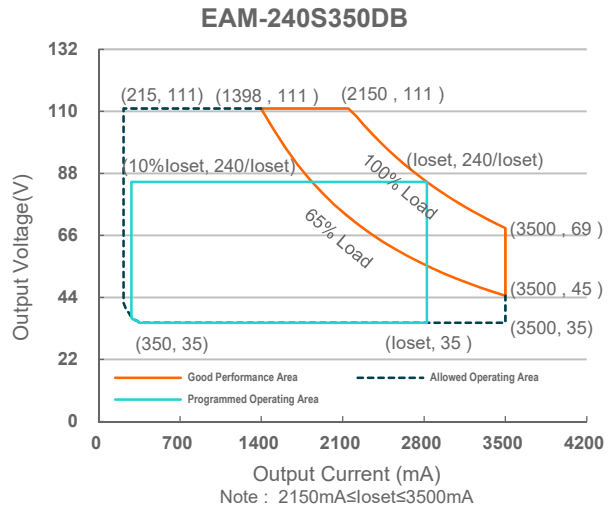
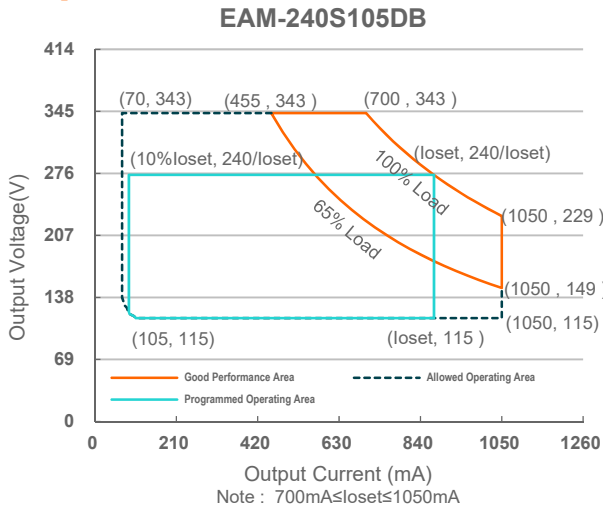

Input Specifications

Parameter	Min.	Typ.	Max.	Notes
Input AC Voltage	90 Vac	-	305 Vac	
Input DC Voltage	127 Vdc	-	300 Vdc	
Input Frequency	47 Hz	-	63 Hz	
Leakage Current	-	-	0.70 mA	IEC 60598-1; 240Vac/ 60Hz
Input AC Current	-	-	2.57 A	Measured at 100% load and 120 Vac input.
	-	-	1.36 A	Measured at 100% load and 220 Vac input.
Inrush Current(I ² t)	-	-	3.45 A ² s	At 220Vac input, 25°C cold start, duration=864us, 10%Ipk-10%Ipk.

Input Specifications (Continued)

Parameter	Min.	Typ.	Max.	Notes
PF	0.9	-	-	At 100-277Vac, 50-60Hz, 65%-100% Load (156-240W)
THD	-	-	20%	
THD	-	-	10%	At 220-240Vac, 50-60Hz, 75%-100% Load (180-240W)

Output Specifications

Parameter	Min.	Typ.	Max.	Notes
Output Current Tolerance	-5%loset	-	5%loset	At 100% load condition
Output Current Setting(loset) Range				
EAM-240S105DB	70 mA	-	1050 mA	
EAM-240S350DB	215 mA	-	3500 mA	
EAM-240S670DB	420 mA	-	6700 mA	
Output Current Setting Range with Constant Power				
EAM-240S105DB	700 mA	-	1050 mA	
EAM-240S350DB	2150 mA	-	3500 mA	
EAM-240S670DB	4200 mA	-	6700 mA	
Total Output Current Ripple (pk-pk)	-	5%lomax	10%lomax	At 100% load condition. 20 MHz BW
Output Current Ripple at < 200 Hz (pk-pk)	-	2%lomax	-	At 100% load condition. Only this component of ripple is associated with visible flicker.
Startup Overshoot Current	-	-	10%lomax	At 100% load condition
No Load Output Voltage				
EAM-240S105DB	-	-	380 V	
EAM-240S350DB	-	-	120 V	
EAM-240S670DB	-	-	70 V	
Line Regulation	-	-	±0.5%	Measured at 100% load
Load Regulation	-	-	±1.5%	
Turn-on Delay Time	-	-	0.5 s	Measured at 120-277Vac input, 65%-100% Load
Temperature Coefficient of loset	-	0.03%/°C	-	Case temperature = 0°C ~Tc max

General Specifications

Parameter	Min.	Typ.	Max.	Notes
Efficiency at 120 Vac input:				
EAM-240S105DB				Measured at 100% load and steady-state temperature in 25°C ambient; (Efficiency will be about 2.0% lower if measured immediately after startup.)
lo= 700 mA	89.0%	91.0%	-	
lo=1050 mA	89.0%	91.0%	-	
EAM-240S350DB				
lo=2150 mA	88.5%	90.5%	-	
lo=3500 mA	88.0%	90.0%	-	
EAM-240S670DB				
lo=4200 mA	88.0%	90.0%	-	
lo=6700 mA	87.5%	89.5%	-	

General Specifications (Continued)

Parameter	Min.	Typ.	Max.	Notes
Efficiency at 220 Vac input: EAM-240S105DB				Measured at 100% load and steady-state temperature in 25°C ambient; (Efficiency will be about 2.0% lower if measured immediately after startup.)
Io= 700 mA	92.0%	94.0%	-	
Io=1050 mA	92.0%	94.0%	-	
EAM-240S350DB				
Io=2150 mA	91.0%	93.0%	-	
Io=3500 mA	90.5%	92.5%	-	
EAM-240S670DB				
Io=4200 mA	91.0%	93.0%	-	
Io=6700 mA	90.0%	92.0%	-	
Efficiency at 277 Vac input: EAM-240S105DB				Measured at 100% load and steady-state temperature in 25°C ambient; (Efficiency will be about 2.0% lower if measured immediately after startup.)
Io= 700 mA	92.5%	94.5%	-	
Io=1050 mA	92.0%	94.0%	-	
EAM-240S350DB				
Io=2150 mA	91.5%	93.5%	-	
Io=3500 mA	91.0%	93.0%	-	
EAM-240S670DB				
Io=4200 mA	91.0%	93.0%	-	
Io=6700 mA	91.0%	93.0%	-	
MTBF	-	346,000 Hours	-	Measured at 220Vac input, 80%Load and 25°C ambient temperature (MIL-HDBK-217F)
Lifetime	-	111,000 Hours	-	Measured at 220Vac input, 80%Load and 70°C case temperature; See lifetime vs. Tc curve for the details
Operating Case Temperature for Safety Tc_s	-20°C	-	+90°C	
Operating Case Temperature for Warranty Tc_w	-20°C	-	+80°C	Case temperature for 5 years warranty Humidity: 10% RH to 95% RH;
Storage Temperature	-20°C	-	+85°C	Humidity: 5%RH to 95%RH
Dimensions				With mounting ear
Inches (L × W × H)	8.31 × 2.36 × 1.52			8.98 × 2.36 × 1.52
Millimeters (L × W × H)	211 × 60 × 38.5			228 × 60 × 38.5
Net Weight	-	950 g	-	

Dimming Specifications

Parameter	Min.	Typ.	Max.	Notes	
Absolute Maximum Voltage on the Vdim (+) Pin	-20 V	-	20 V		
Source Current on Vdim (+)Pin	200 µA	300 µA	450 µA	Vdim(+) = 0 V	
Dimming Output Range	EAM-240S105DB EAM-240S350DB EAM-240S670DB	10%Io	-	Io	700 mA ≤ Io ≤ 1050 mA 2150 mA ≤ Io ≤ 3500 mA 4200 mA ≤ Io ≤ 6700 mA
	EAM-240S105DB EAM-240S350DB EAM-240S670DB	70 mA 215 mA 420 mA	-	Io	70 mA ≤ Io < 700 mA 215 mA ≤ Io < 2150 mA 420 mA ≤ Io < 4200 mA
	Recommended Dimming Input Range	0 V	-	10 V	Default 0-10V dimming mode.

Dimming Specifications (Continued)

Parameter	Min.	Typ.	Max.	Notes
PWM_in High Level	3 V	-	10 V	
PWM_in Low Level	-0.3 V	-	0.6 V	
PWM_in Frequency Range	200 Hz	-	3 KHz	
PWM_in Duty Cycle	1%	-	99%	

Safety & EMC Compliance

Safety Category	Standard
CE	EN 61347-1, EN 61347-2-13
BIS	IS 15885(Part2/Sec13)
EMI Standards	Notes
EN IEC 55015 ⁽¹⁾	Conducted emission Test & Radiated emission Test
EN IEC 61000-3-2	Harmonic current emissions
EN 61000-3-3	Voltage fluctuations & flicker
EMS Standards	Notes
EN 61000-4-2	Electrostatic Discharge (ESD): 8 kV air discharge, 4 kV contact discharge
EN 61000-4-3	Radio-Frequency Electromagnetic Field Susceptibility Test-RS
EN 61000-4-4	Electrical Fast Transient / Burst-EFT
EN 61000-4-5	Surge Immunity Test: AC Power Line: Differential Mode 4 kV, Common Mode 6 kV
EN 61000-4-6	Conducted Radio Frequency Disturbances Test-CS
EN 61000-4-8	Power Frequency Magnetic Field Test
EN 61000-4-11	Voltage Dips
EN 61547	Electromagnetic Immunity Requirements Applies To Lighting Equipment

Note: (1) This LED driver meets the EMI specifications above, but EMI performance of a luminaire that contains it depends also on the other devices connected to the driver and on the fixture itself.

Derating

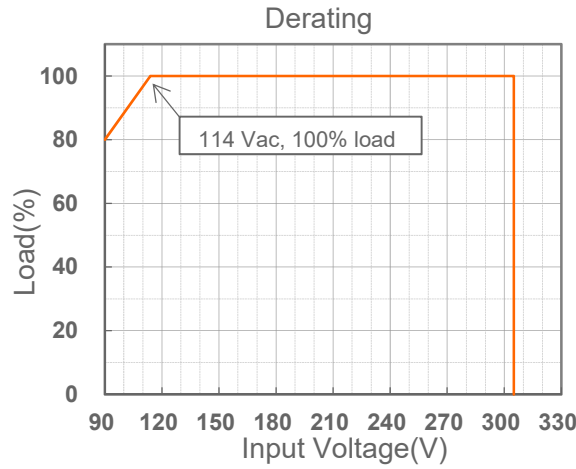

Lifetime vs. Case Temperature

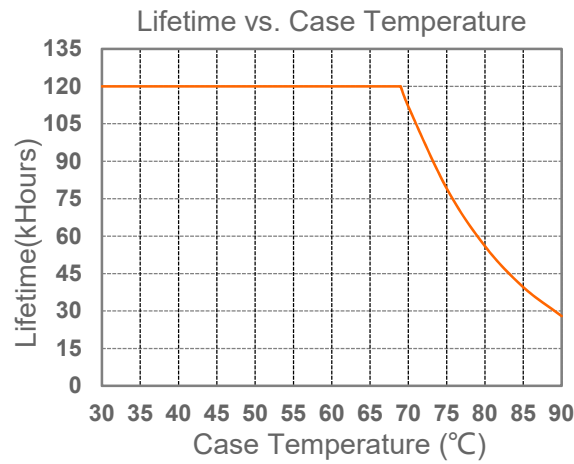

Inrush Current Waveform

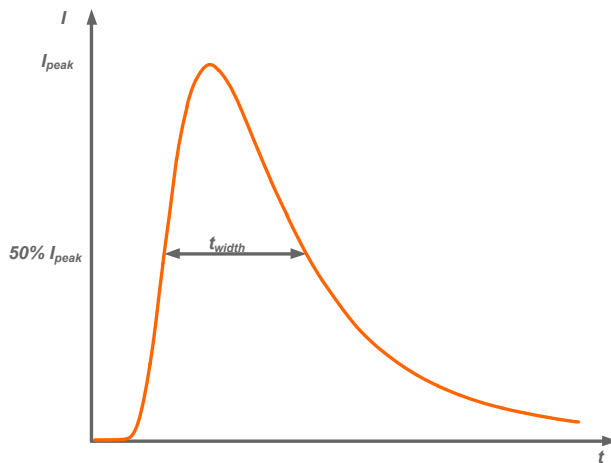

Input AC Voltage	I_{peak}	t_{width} (@ 50% I_{peak})
220V	73.0A	388 μ s

Efficiency vs. Load

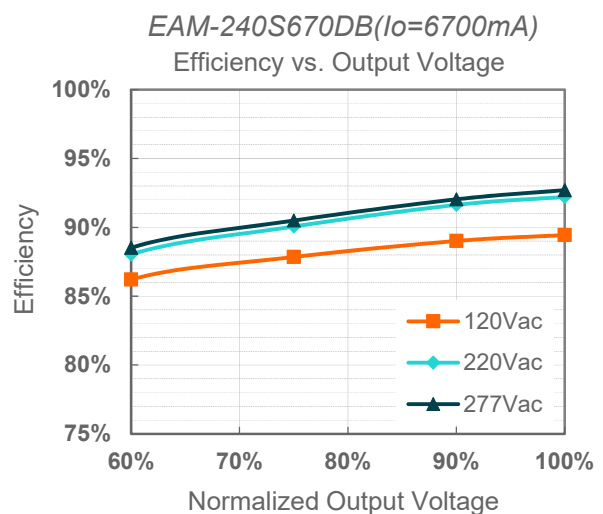
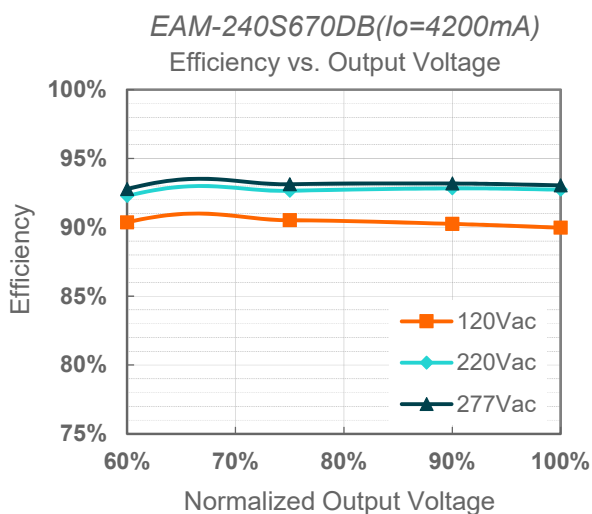
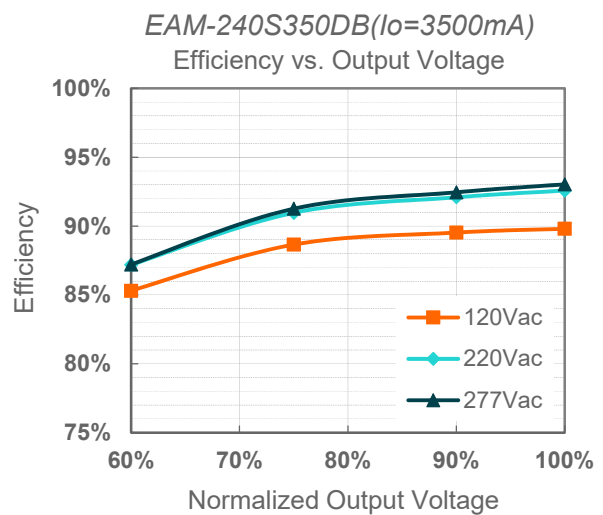
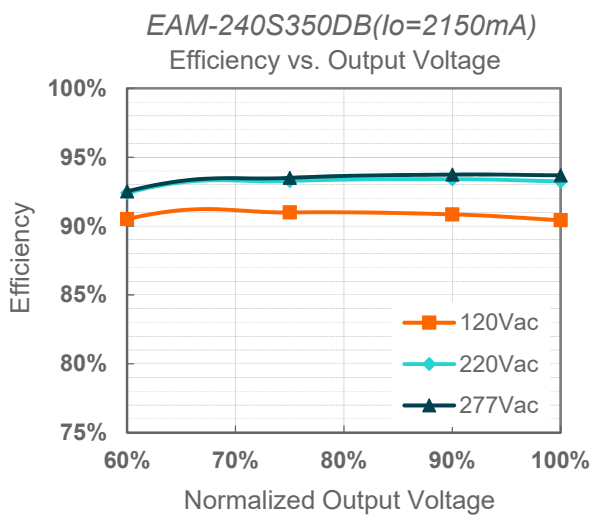
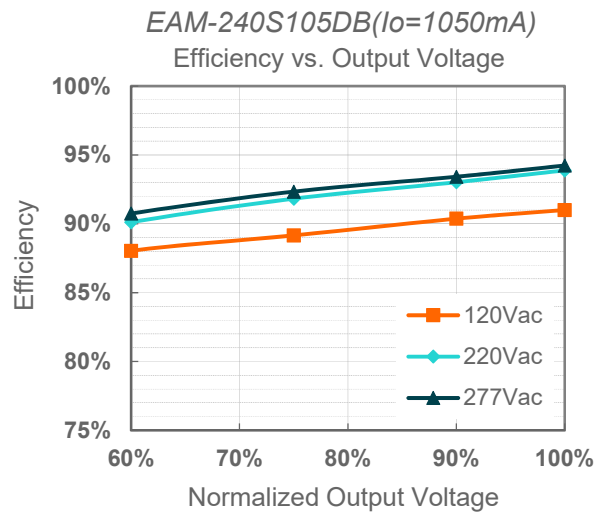
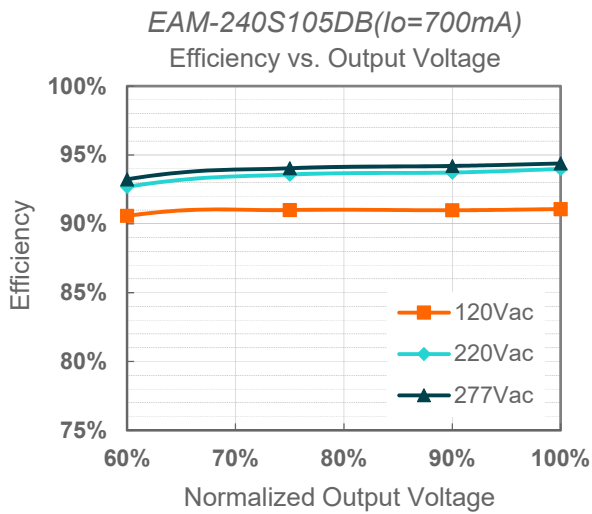

Power Factor

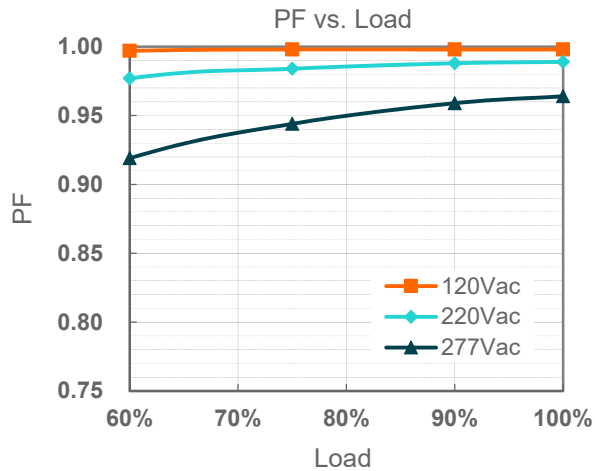

Total Harmonic Distortion

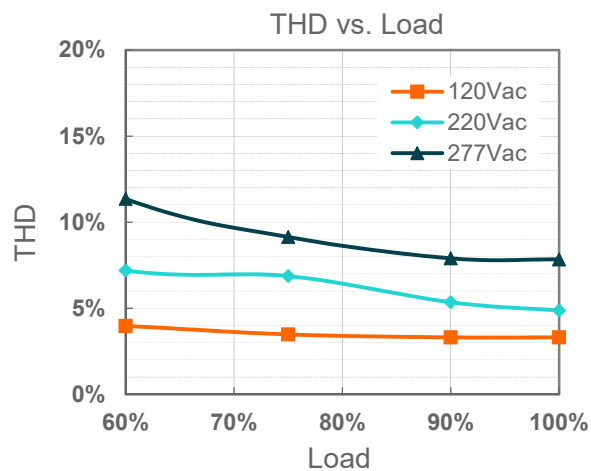

Protection Functions

Parameter		Min.	Typ.	Max.	Notes
Over Voltage Protection		Limits output voltage at no load and in case the normal voltage limit fails.			
Short Circuit Protection		Auto Recovery. No damage will occur when any output is short circuited. The output shall return to normal when the fault condition is removed.			
Over Temperature Protection		Decreases output current, returning to normal after over temperature is removed.			
Input Over Voltage Protection	Input Over Voltage Protection	320 Vac	340 Vac	360 Vac	Turn off the output when the input voltage exceeds protection voltage.
	Input Over Voltage Recovery	300 Vac	320 Vac	340 Vac	Auto Recovery. The driver will restart when the input voltage falls below recovery voltage.
	Max. of Input Over Voltage	-	-	440 Vac	The driver can survive for 48 hours with input voltage stress of 440Vac.

● Input Over Voltage Protection Diagram

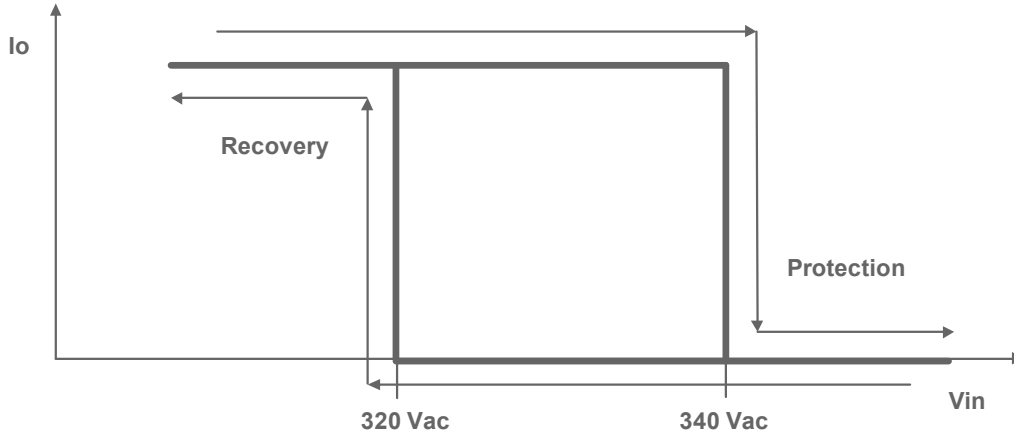

Dimming

● 0-10V Dimming

The recommended implementation of the dimming control is provided below.

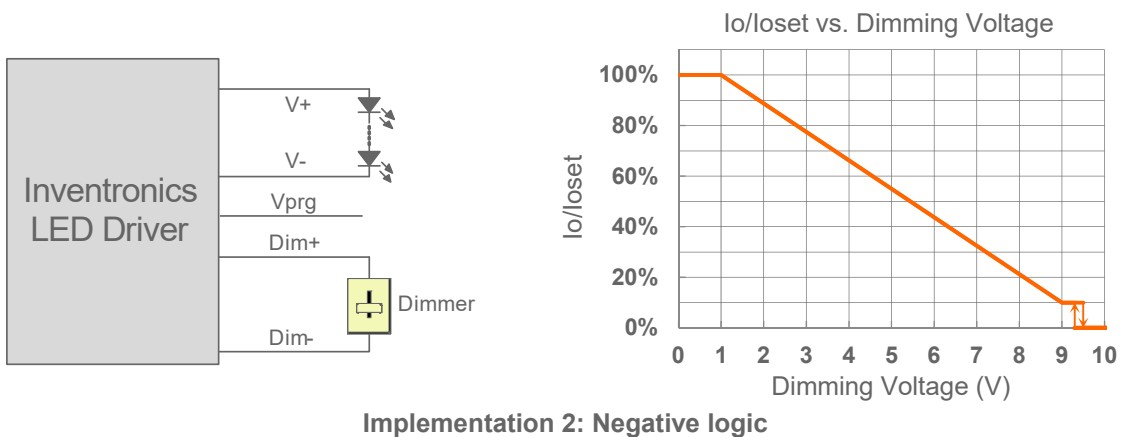
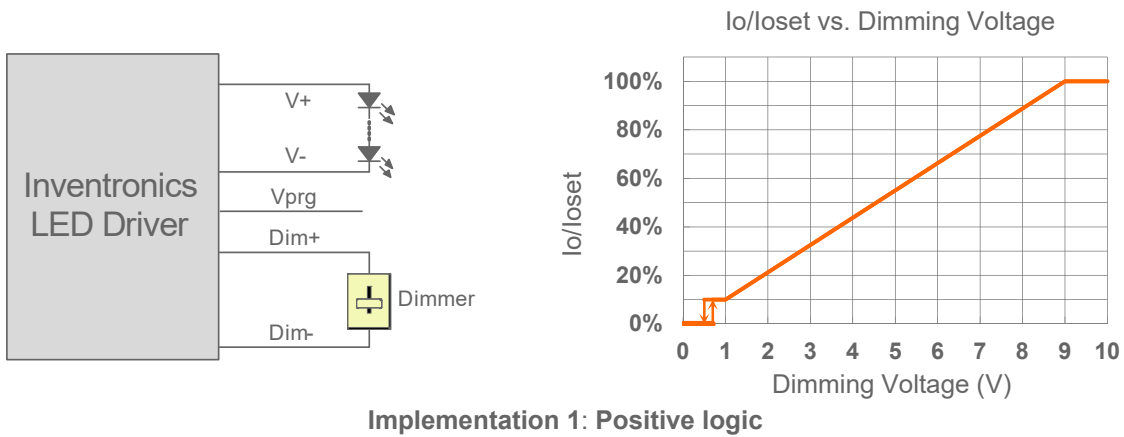

Notes:

1. Do NOT connect Dim- to the output V- or V+, otherwise the driver will not work properly.
2. The dimmer can also be replaced by an active 0-10V voltage source signal or passive components like zener.
3. When 0-10V negative logic dimming mode and Dim+ is open, the driver will output minimum current.

● **10V PWM Dimming**

The recommended implementation of the dimming control is provided below.

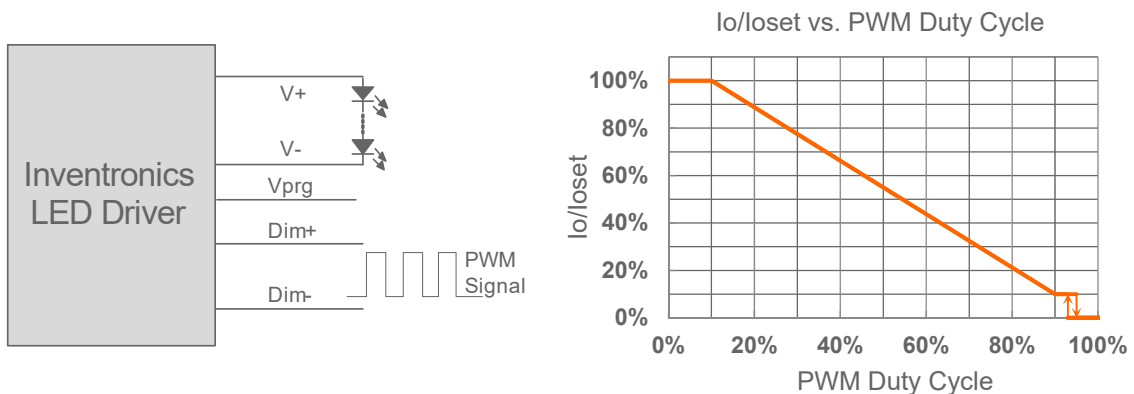
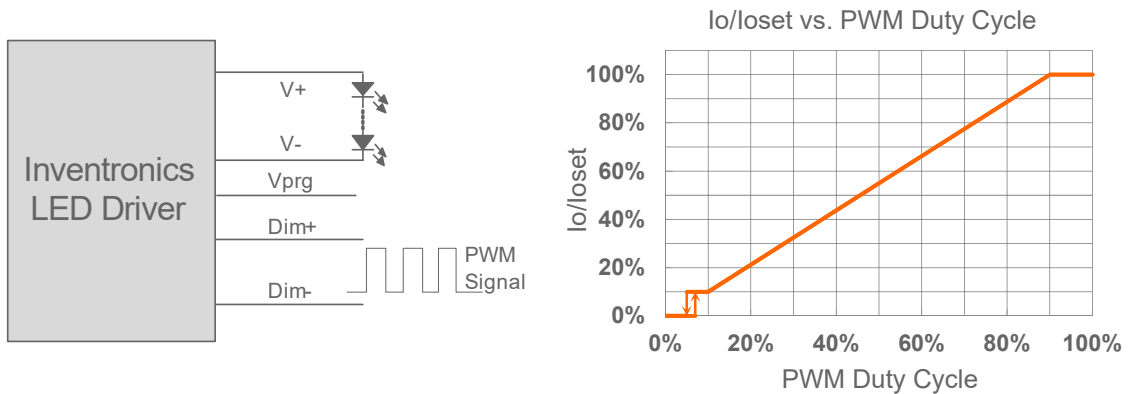

Notes:

1. Do NOT connect Dim- to the output V- or V+, otherwise the driver will not work properly.
2. When 10V PWM negative logic dimming mode and Dim+ is open, the driver will output minimum current.

● **Time Dimming**

Time dimming control includes 3 kinds of modes, they are Self Adapting-Midnight, Self Adapting-Percentage and Traditional Timer.

- **Self Adapting-Midnight:** Automatically adjusts the dimming curve based on the on-time of past two days (if difference <15 minutes), assuming that the center point of the dimming curve is midnight local time.
- **Self Adapting-Percentage:** Automatically adjusts the on-time of each step by a constant percentage = (actual on-time for the past 2 days if difference <15 min) / (programmed on-time from the dimming curve).
- **Traditional Timer:** Follows the programmed timing curve after power on with no changes.

● Output Lumen Compensation

Output Lumen Compensation (OLC) may be used to maintain constant light output over the life of the LEDs by driving them at a reduced current when new, then gradually increasing the drive current over time to counteract LED lumen degradation.

Programming Connection Diagram

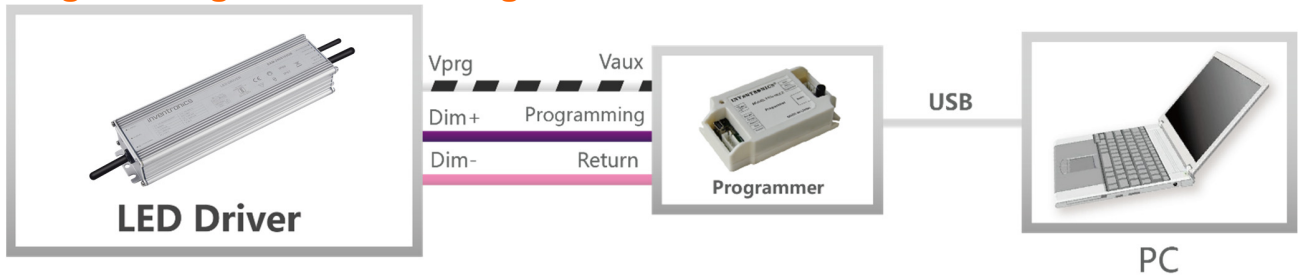

Note: The driver does not need to be powered on during the programming process.

● Please refer to [PRG-MUL2 \(Programmer\)](#) datasheet for details.

Mechanical Outline

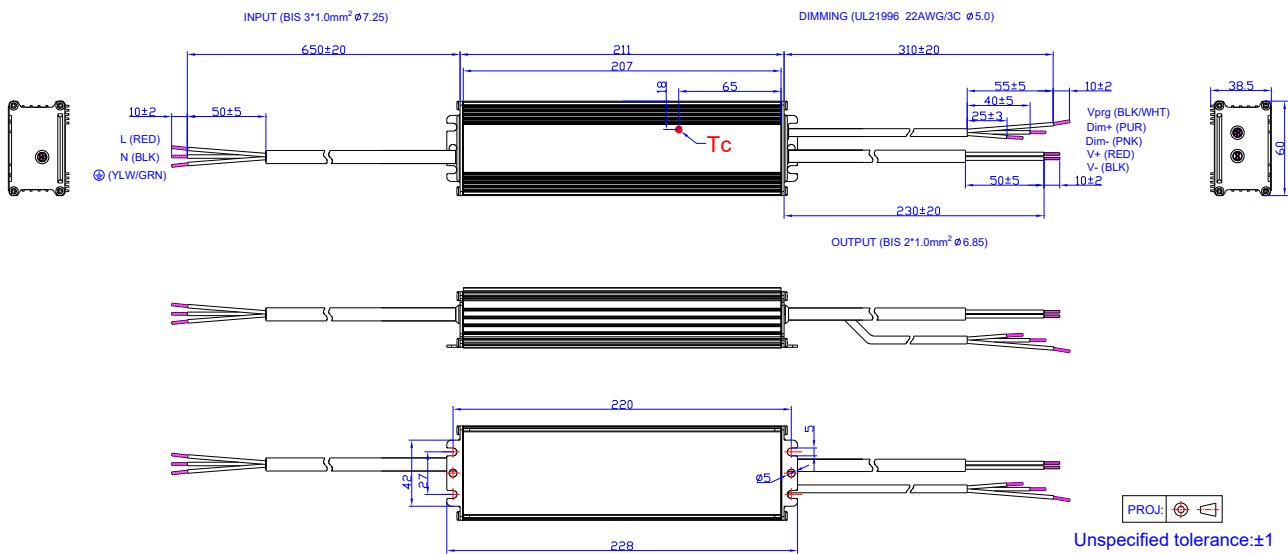

RoHS Compliance

Our products comply with reference to RoHS Directive (EU) 2015/863 amending 2011/65/EU, calling for the elimination of lead and other hazardous substances from electronic products.

Revision History

Change Date	Rev.	Description of Change		
		Item	From	To
2023-12-07	A	Datasheet Release	/	/