

Features

- Ultra High Efficiency (Up to 94.0%)
- Adjustable Output Current (AOC) with External Resistor
- Full Power at Wide Output Current Range (Constant Power)
- Flicker- Free
- Non-dimming Control
- 89,000 Hours Lifetime at 70°C Case Temperature
- Input Surge Protection: 1kV line-line, 2kV line-earth
- Suitable for Luminaires with Protection Class I
- Complies with Zhaga Interface Specification Book 13
- Non-Isolated Design
- 5 Year Warranty



Description

The LMT-080SxxxSTF series is a 80W, constant-current, IP20 LED driver that operates from 198-264 Vac input with excellent power factor. Created for linear troffer and panel lighting, the high efficiency of these drivers and slim metal case enables them to run cooler, significantly improving reliability and extending product life. To ensure trouble-free operation, protection is provided against over voltage, short circuit, and over temperature.

Models

Adjustable Output Current Range	Full-Power Current Range (1)	Default Output Current	Input Voltage Range(2)	Output Voltage Range	Max. Output Power	Typical Efficiency (3)	Power Factor (3)	Model Number
250-500mA	350-500mA	< 250mA	198~264 Vac 190~250 Vdc	96-229Vdc	80 W	94.0%	0.98	LMT-080S050STF
340-700mA	500-700mA	< 340mA	198~264 Vac 190~250 Vdc	68-160Vdc	80 W	94.0%	0.98	LMT-080S070STF
500-1050mA	700-1050mA	< 500mA	198~264 Vac 190~250 Vdc	45-114Vdc	80 W	93.0%	0.98	LMT-080S105STF

Notes: (1) Output current range with constant power at 80W

(2) Certified voltage range: 220-240Vac or 190-250Vdc (except CCC)

(3) Measured at 100% load and 220Vac input (see below "General Specifications" for details).

Input Specifications

Parameter	Min.	Typ.	Max.	Notes
Input Voltage	198 Vac	-	264 Vac	190~250 Vdc
Input Frequency	47 Hz	-	63 Hz	
Leakage Current	-	-	0.70 mA	IEC60598-1; 240Vac/ 60Hz
Input AC Current	-	-	0.43 A	Measured at 100% load and 220 Vac input.
Inrush Current(I ² t)	-	-	0.35 A ² s	At 220Vac input, 25°C Cold Start, Duration =194 μs, 10%Ipk-10%Ipk. See Inrush Current Waveform for the details.

Input Specifications (Continued)

Parameter	Min.	Typ.	Max.	Notes
PF	0.90	-	-	At 220-240Vac, 50-60Hz, 70%-100% Load (56-80W)
THD	-	-	20%	
THD	-	-	10%	At 220-240Vac, 50-60Hz, 75%-100% Load (60-80W)

Output Specifications

Parameter	Min.	Typ.	Max.	Notes
Output Current Tolerance	-5%loset	-	5%loset	At 100% load condition
Output Current Setting(loset) Range				
LMT-080S050STF	250 mA	-	500 mA	
LMT-080S070STF	340 mA	-	700 mA	
LMT-080S105STF	500 mA	-	1050 mA	
Output Current Setting Range with Constant Power				
LMT-080S050STF	350 mA	-	500 mA	
LMT-080S070STF	500 mA	-	700 mA	
LMT-080S105STF	700 mA	-	1050 mA	
Total Output Current Ripple (pk-pk)	-	30%Iomax	50%Iomax	At 100% load condition
Output Current Ripple at < 200 Hz (pk-pk)	-	2%Iomax	-	At 100% load condition. Only this component of ripple is associated with visible flicker.
Startup Overshoot Current	-	-	10%Iomax	At 100% load condition
No Load Output Voltage	-	-	400 V	
Line Regulation	-	-	± 1%	Measured at 100% load
Load Regulation	-	-	± 5%	
Turn-on Delay Time	-	-	0.5 s	Measured at 220-240Vac input, 70%-100%load
Temperature Coefficient of loset	-	0.06%/°C	-	Case temperature = 0°C ~Tc max

Note: All specifications are typical at 25°C unless otherwise stated.

General Specifications

Parameter	Min.	Typ.	Max.	Notes
Efficiency at 220 Vac input: LMT-080S050STF				Measured at 100% load and steady-state temperature in 25°C ambient; (Efficiency will be about 2.0% lower if measured immediately after startup.)
Io= 350 mA	92.00%	94.00%	-	
Io= 500 mA	91.50%	93.50%	-	
LMT-080S070STF				
Io= 500 mA	92.00%	94.00%	-	
Io= 700 mA	91.50%	93.50%	-	
LMT-080S105STF				
Io= 700 mA	91.00%	93.00%	-	
Io=1050 mA	90.00%	92.00%	-	

General Specifications (Continued)

Parameter	Min.	Typ.	Max.	Notes
MTBF	-	327,000 Hours	-	Measured at 220Vac input, 80%Load and 25°C ambient temperature (MIL-HDBK-217F)
Lifetime	-	89,000 Hours	-	Measured at 220Vac input, 80%Load and 70°C case temperature; See lifetime vs. Tc curve for the details
Operating Case Temperature for Safety Tc_s	-30°C		+90°C	
Operating Case Temperature for Warranty Tc_w	-30°C		+75°C	Case temperature for 5 years warranty. No condensation.
Storage Temperature	-30°C	-	+85°C	Humidity: 5%RH to 85%RH; No condensation.
Dimensions Inches (L × W × H) Millimeters (L × W ×H)	11.02 × 1.18 × 0.83 280 × 30 × 21			
Net Weight	-	245 g	-	

Note: All specifications are typical at 25°C unless otherwise stated.

Safety & EMC Compliance

Safety Category	Standard
ENEC & CE	EN61347-1, EN61347-2-13
CCC	GB 19510.1, GB 19510.14
KS	KS C 7655
Performance	Standard
ENEC	EN 62384
EMI Standards	Notes
EN 55015/GB 17743 ⁽¹⁾	Conducted emission Test & Radiated emission Test
EN 61000-3-2/GB 17625.1	Harmonic current emissions
EN 61000-3-3	Voltage fluctuations & flicker
EMS Standards	Notes
EN 61000-4-2	Electrostatic Discharge (ESD): 8 kV air discharge, 4 kV contact discharge
EN 61000-4-3	Radio-Frequency Electromagnetic Field Susceptibility Test-RS
EN 61000-4-4	Electrical Fast Transient / Burst-EFT
EN 61000-4-5	Surge Immunity Test: AC Power Line: Differential Mode 1 kV, Common Mode 2 kV
EN 61000-4-6	Conducted Radio Frequency Disturbances Test-CS
EN 61000-4-8	Power Frequency Magnetic Field Test
EN 61000-4-11	Voltage Dips

Safety & EMC Compliance (Continued)

EMS Standards	Notes
EN 61547	Electromagnetic Immunity Requirements Applies To Lighting Equipment

Notes: (1) This LED driver meets the EMI specifications above, but EMI performance of a luminaire that contains it depends also on the other devices connected to the driver and on the fixture itself.

Lifetime vs. Case Temperature

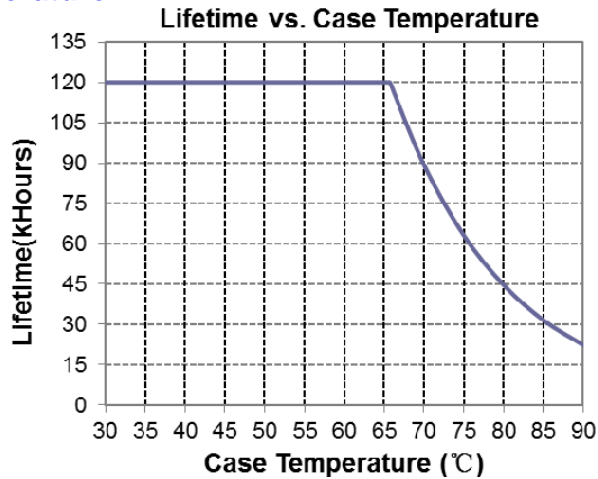

Inrush Current Waveform

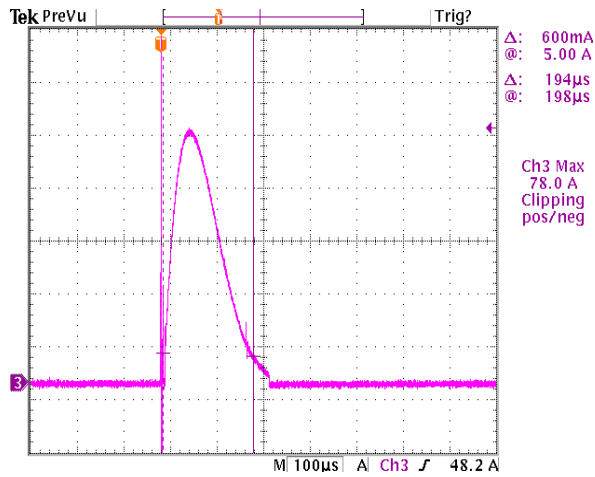

Efficiency vs. Load

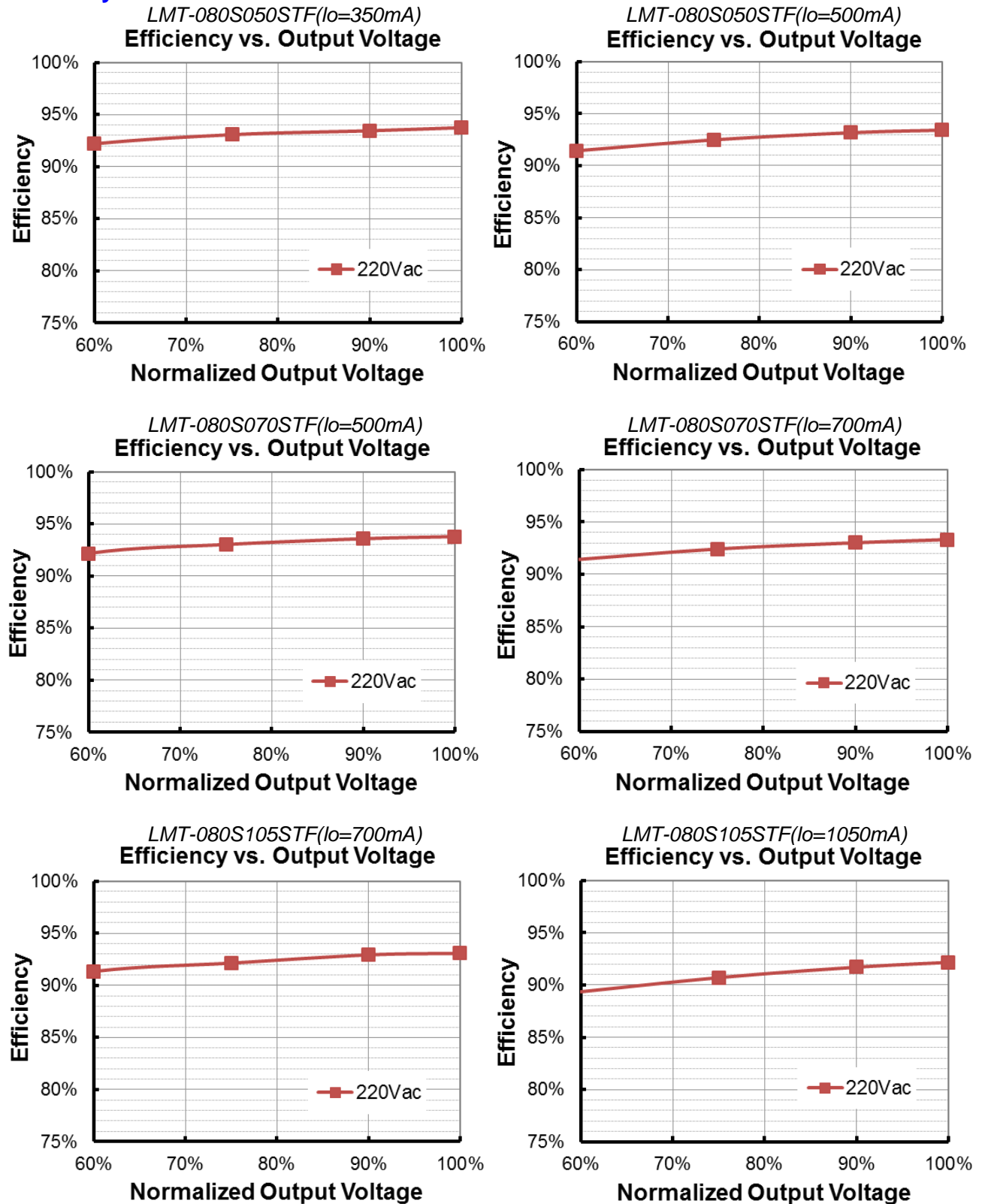

Power Factor

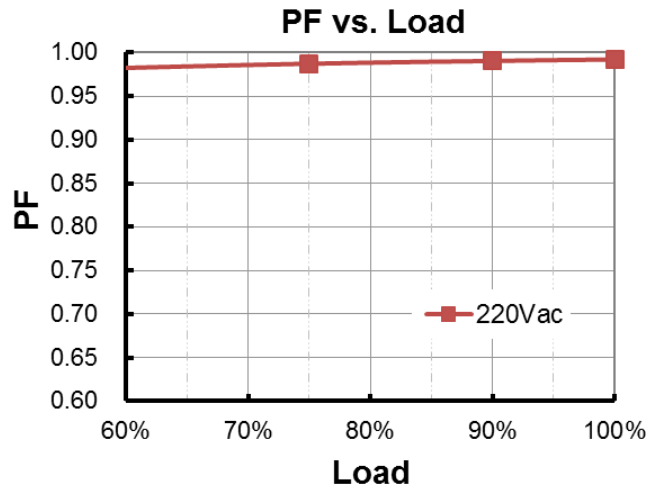

Total Harmonic Distortion

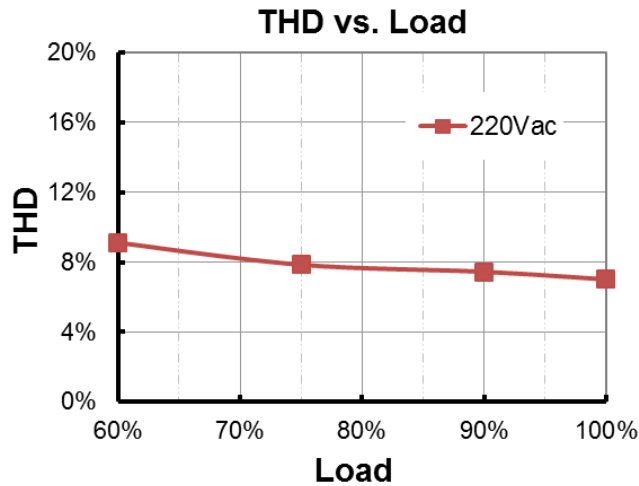

Protection Functions

Parameter	Notes
Over Temperature Protection	Decreases output current, returning to normal after over temperature is removed.
Short Circuit Protection	Auto Recovery. No damage will occur when any output is short circuited. The output shall return to normal when the fault condition is removed.
Over Voltage Protection	Limits output voltage at no load and in case the normal voltage limit fails.

Wire Connection

Parameter		Min.	Typ.	Max.	Notes
L, N, 	Wire Cross-section	0.5 mm ²	-	1.5 mm ²	Push-in at 45° angle, solid and stranded wire
		20 AWG	-	16 AWG	
	Strip Length	8 mm	-	9 mm	
LED+, LED+, LED-, LED-, Iset+, Iset-	Wire Cross-section	0.5 mm ²	-	1.5 mm ²	Push-in at 45° angle, solid and stranded wire
		20 AWG	-	16 AWG	
	Strip Length	8 mm	-	9 mm	

Wire Connection 1

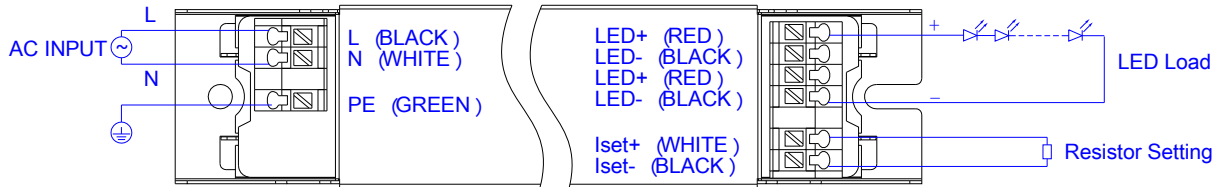

Wire Connection 2

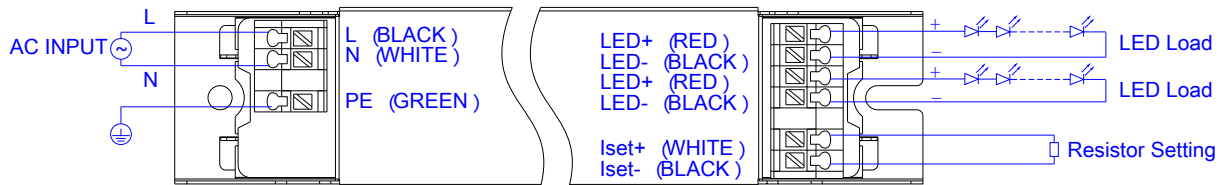

Output Current vs. Resistor Setting (Iset)

● LMT-080S050STF

Resistor Setting (Iset)	Output Current	Output Voltage Range		Notes
		Min.	Max.	
Typ.	Typ.			/
10.00 kΩ	500mA	96V	160V	Output Current Setting with Constant Power.
10.53 kΩ	475mA	96V	168V	
11.11 kΩ	450mA	96V	178V	
11.76 kΩ	425mA	96V	188V	
12.50 kΩ	400mA	100V	200V	
13.33 kΩ	375mA	107V	213V	
14.29 kΩ	350mA	115V	229V	
15.38 kΩ	325mA	124V	229V	Output Current Setting with Power Derating.
16.67 kΩ	300mA	134V	229V	
18.18 kΩ	275mA	146V	229V	
20.00 kΩ	250mA	160V	229V	

● LMT-080S070STF

Resistor Setting (Iset)	Output Current	Output Voltage Range		Notes
		Min.	Max.	
Typ.	Typ.			/
7.14 kΩ	700mA	68V	114V	Output Current Setting with Constant Power.
7.58 kΩ	660mA	68V	121V	
8.06 kΩ	620mA	68V	129V	
8.62 kΩ	580mA	69V	138V	
9.26 kΩ	540mA	74V	148V	
10.00 kΩ	500mA	80V	160V	
10.87 kΩ	460mA	87V	160V	Output Current Setting with Power Derating.
11.90 kΩ	420mA	96V	160V	
13.16 kΩ	380mA	106V	160V	
14.71 kΩ	340mA	118V	160V	

● LMT-080S105STF

Resistor Setting (Iset)	Output Current	Output Voltage Range		Notes
		Min.	Max.	
Typ.	Typ.			/
4.76 kΩ	1050mA	45V	76V	Output Current Setting with Constant Power.
5.00 kΩ	1000mA	45V	80V	
5.26 kΩ	950mA	45V	84V	
5.56 kΩ	900mA	45V	89V	
5.88 kΩ	850mA	47V	94V	
6.25 kΩ	800mA	50V	100V	
6.67 kΩ	750mA	54V	107V	
7.14 kΩ	700mA	57V	114V	
7.69 kΩ	650mA	62V	114V	Output Current Setting with Power Derating.
8.33 kΩ	600mA	67V	114V	
9.09 kΩ	550mA	73V	114V	
10.00 kΩ	500mA	80V	114V	

Notes:

1. An external resistor must be set in the setting range as specified to insure the driver operates as expected.
2. Either short circuit or open circuit is not allowed for long-term operation.

Mechanical Outline

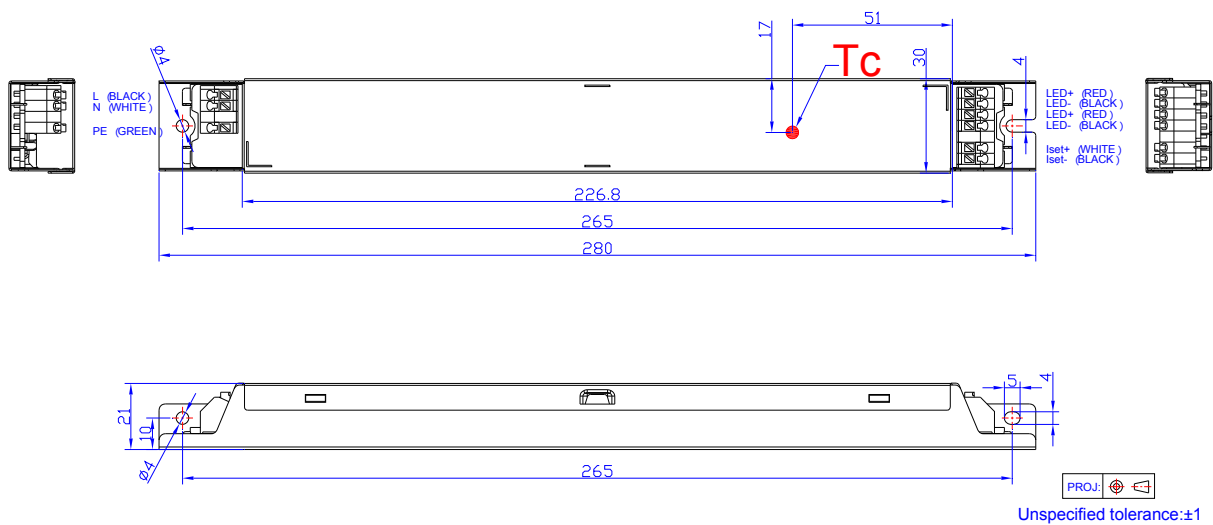

RoHS Compliance

Our products comply with the European Directive 2011/65/EC, calling for the elimination of lead and other hazardous substances from electronic products.

Revision History

Change Date	Rev.	Description of Change		
		Item	From	To
2019-01-17	A	Datasheets Release	/	/